

PRODUCT DATASHEET

FL PFM 80 W 4000 K SYM 100 BK

FLOODLIGHT 80 W | Versatile floodlight with up to 10000 lm light output



Areas of application

- Replacement for floodlights with halogen lamps
- Outdoor use (IP65)
- Industry
- Public areas
- Construction areas
- Building facades

Product benefits

- Bright, robust and durable
- Safe and very uniform illumination, due to frosted and tempered glass diffuser
- No upper light output ratio (ULOR 0%) when mounted at 0° tilt
- Energy savings of up to 90 % compared to halogen lamp floodlights
- 5 years guarantee

Product features

- Reflector-based, symmetric light distribution with 100° x 100° beam angle
- Integrated wide voltage driver, suitable for 100 - 277 V AC
- Surge protection: up to 6 kV (L/N-PE), 4 kV (L-N)
- Mounting bracket with 30° angle and wide rotation area
- Breather membrane to optimize air exchange, without compromising IP protection
- Pre-installed, flexible 1 m cable (H05RN-F), wrapped 3 x 1.0 mm² single wires



TECHNICAL DATA

Electrical data

Nominal wattage	80.00 W
Operating mode	Integrated LED driver
Nominal voltage	100...277 V
Nominal current	430 mA
Inrush current	14.8 A
Inrush current time T_{h50}	160 μ s
Power factor λ	> 0.90
Mains frequency	50...60 Hz
Max. no. of lum. on circuit break. B16 A	24
Max. no. of lum. on circuit break. C10 A	17
Max. no. of lum. on circuit break. C16 A	28
Total harmonic distortion	< 20 %

Luminaire control gear data

Output current	870 mA
ECG - Output ripple current	< 35 %

Photometrical data

Color temperature	4000 K
Luminous flux	10000 lm
Luminous efficacy	125 lm/W
Light color (designation)	Cool White
Standard deviation of color matching	≤ 5 sdcn
Color rendering index Ra	≥ 80

Light technical data

Beam angle	100 ° x 100 °
------------	---------------

Dimensions & weight

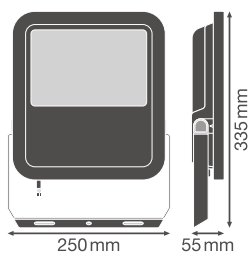

Length	335.00 mm
Height	55.00 mm
Width	250.00 mm
Cable length	1000 mm
Product weight	2800.00 g

Colors & materials

Body material	Aluminum
Product color	Black
Housing color	Black
Light emitting surface material	Glass

Temperatures & operating conditions

Ambient temperature range	-30...+50 °C
---------------------------	--------------

Lifespan

Number of switching cycles	100000
Lifespan L70/B50 at 25 °C	70000 h
Lifespan L80/B10 at 25 °C	55000 h
Lifespan L90/B10 at 25 °C	35000 h

Additional product data

Mounting type	Surface
Mounting location	Wall / Pole / Floor / Ceiling
Product remark	Available from September 2020

Capabilities

Adjustable	Yes
------------	-----

Dimmable	No
Type of connection	Cable, 3-pole
LED module replaceable	Not replaceable

Certificates & standards

Protection class IK (shock resistance)	IK08
Glow Wire Test according to IEC 60695-2-12	650 °C
Photobiological safety group acc. to EN62778	RG1
Photobiological safety group acc. to EN62471	RG1
Protection class	I
Type of protection	IP65
Ball shot safe	No
Standards	CE / CB / ENEC / EAC / RoHS
Luminaire with limited surface temperature, class "D"	No



LDC typ cone

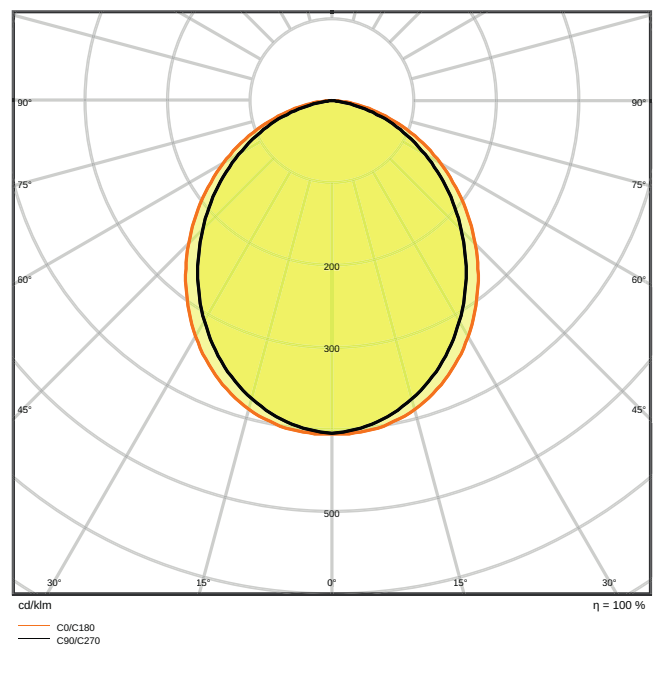

LDC typ polar









LOGISTICAL DATA

Temperature range at storage	-40...+70 °C
------------------------------	--------------

Safety advice

– Max. wind load surface 0.061 m²

DOWNLOAD DATA

DOWNLOAD DATA	
	User instruction FLOODLIGHT 65W - 200W
	Tender documents Tender Text 4058075422520
	Declarations of conformity FLOODLIGHT PFM
	IES file (IES) FL PFM 80W4000K SYM 100 BK
	LDT file (Eulumdat) FL PFM 80W4000K SYM 100 BK
	R3D file (Relux 3D Model) FL PFM 80W
	M4D file (3D Model with rotation axis) FL PFM 80W
	UGR file (UGR table) FL PFM 80W4000K SYM 100 BK
	Packaging insert Legal insert

LOGISTICAL DATA

Product code	Packaging unit (Pieces/Unit)	Dimensions (length x width x height)	Gross weight	Volume
4058075422520	Folding box 1	62 mm x 257 mm x 352 mm	2957.00 g	5.61 dm ³
4058075422537	Shipping box 2	302 mm x 170 mm x 414 mm	6326.00 g	21.25 dm ³

The mentioned product code describes the smallest quantity unit which can be ordered. One shipping unit can contain one or more single products. When placing an order, for the quantity please enter single or multiples of a shipping unit.

ADDITIONAL CATALOG INFORMATION

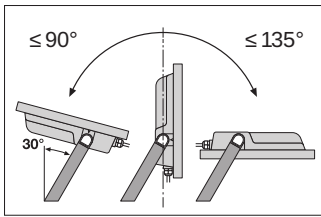

	A	B	C	⚙️	🔌
55W	150	108	8,5	2x M8	0,046m ²
80W	150	108	10,5	2x M10	0,061m ²
122W	170	118	10,5	2x M10	0,083m ²
160W	170	118	12,5	2x M12	0,102m ²
200W	170	118	12,5	2x M12	0,124m ²

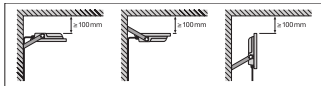
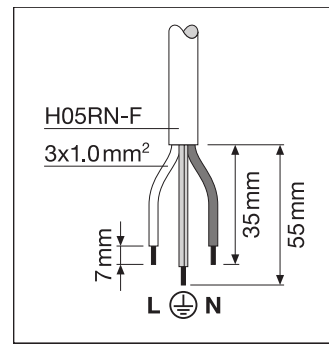

References / Links

- For Guarantee see www.ledvance.com/guarantee

DISCLAIMER

Subject to change without notice. Errors and omission excepted. Always make sure to use the most recent release.